

Selected match: (2) BUL19, BUL19

Analysis selection

Romania | 1 Vaida | Attack | (XF,X2,X1,XM,XG,XC,X7,X9,XT,X3,X4,XB,XP,XR,X5,X0,X6,X8,CB,CF,CD,C5,C0,C6,C8,V5,V0,V6,V8,VB,VP,VR)

**X5** Ind. \*E% N # #% = /  
5 9% 22 9 41% 4 3

**V5** Ind. \*E% N # #% = /  
5 . 11 2 18% 0 2

**X6** Ind. \*E% N # #% = /  
8 50% 6 3 50% 0 0

**XP** Ind. \*E% N # #% = /  
3 -33 6 1 17% 2 1

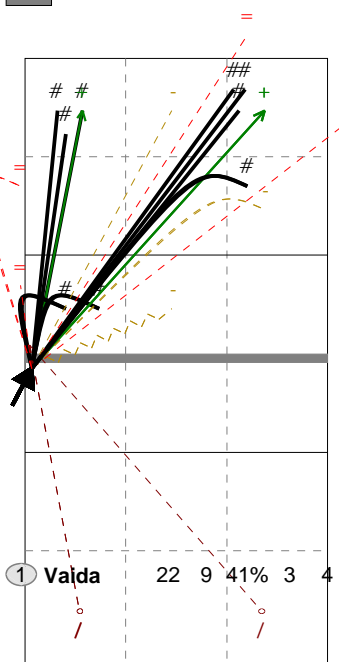

H: 73%(16) P: 5%(1) T: 23%(5)

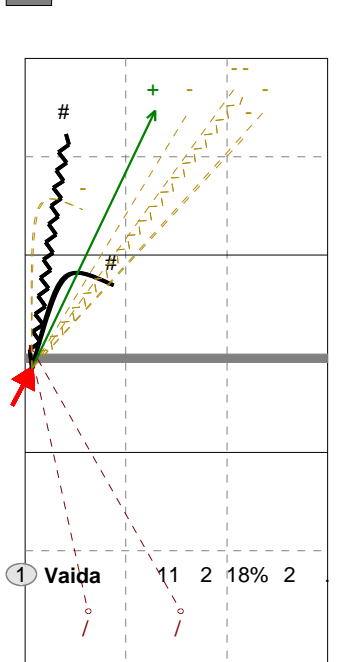

H: 64%(7) P: 18%(2) T: 18%(2)

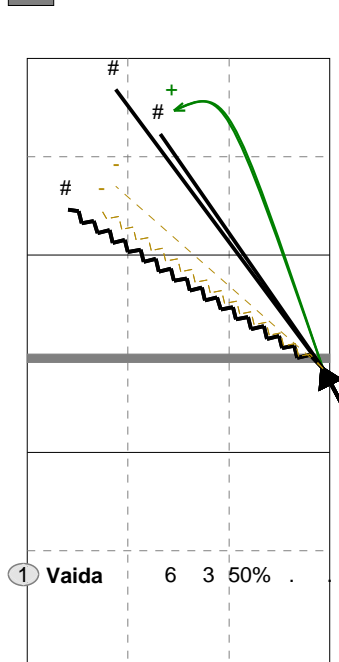

H: 50%(3) P: 33%(2) T: 17%(1)

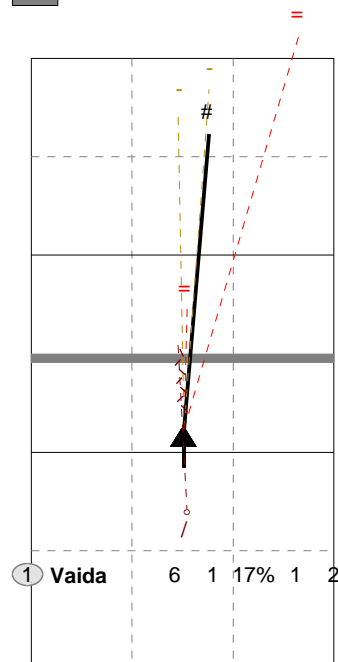

H: 83%(5) P: 17%(1) T: (0)

**VP** Ind. \*E% N # #% = /  
3 -33 3 0 0% 1 0

**V6** Ind. \*E% N # #% = /  
10 100 1 1 100 0 0

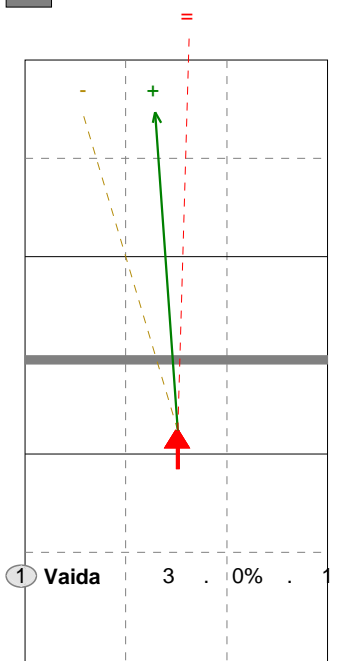

H: 100%(3) P: (0) T: (0)

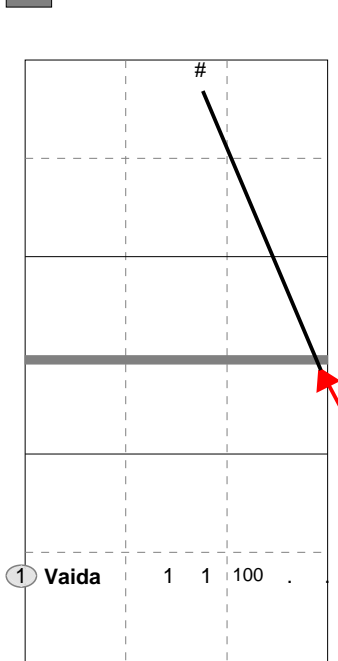

H: 100%(1) P: (0) T: (0)



Selected match: (2) BUL19, BUL19

Analysis selection

Romania | 3 Filipas | Attack | (X2,X1,XC,X7)

| XC | Ind. | *E% | N  | # | #%  | = | / |
|----|------|-----|----|---|-----|---|---|
|    | 8    | 58% | 12 | 9 | 75% | 0 | 2 |

| X1 | Ind. | *E% | N | # | #%  | = | / |
|----|------|-----|---|---|-----|---|---|
|    | 6    | 17% | 6 | 1 | 17% | 0 | 0 |

| X7 | Ind. | *E% | N | # | #%  | = | / |
|----|------|-----|---|---|-----|---|---|
|    | 9    | 80% | 5 | 4 | 80% | 0 | 0 |

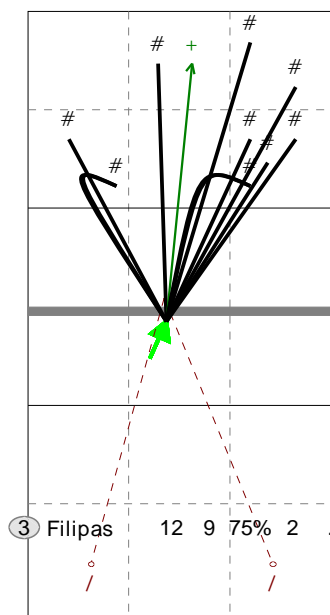

H: 83%(10) P: (0) T: 17%(2)

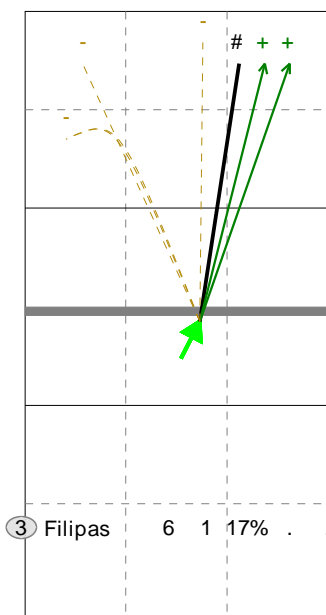

H: 83%(5) P: (0) T: 17%(1)

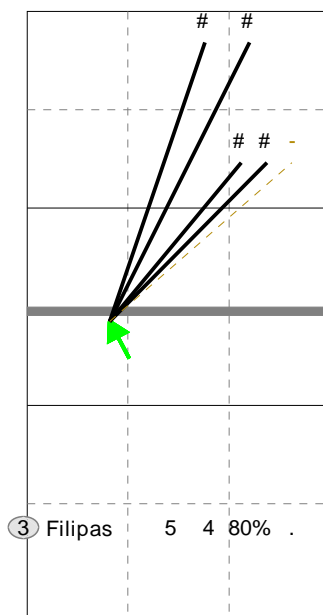

H: 100%(5) P: (0) T: (0)



Selected match: (2) BUL19, BUL19

Analysis selection

Romania | 6 Rosca | Attack | (XF,X2,X1,XM,XG,XC,X7,X9,XT,X3,X4,XB,XP,XR,X5,X0,X6,X8,CB,CF,CD,C5,C0,C6,C8,V5,V0,V6,V8,VB,VP,VR)

|           |      |     |   |   |    |   |   |
|-----------|------|-----|---|---|----|---|---|
| <b>X6</b> | Ind. | *E% | N | # | #% | = | / |
|           | 4    | -29 | 7 | 0 | 0% | 1 | 1 |

|           |      |     |   |   |     |   |   |
|-----------|------|-----|---|---|-----|---|---|
| <b>V6</b> | Ind. | *E% | N | # | #%  | = | / |
|           | 8    | 67% | 3 | 2 | 67% | 0 | 0 |

|           |      |     |   |   |     |   |   |
|-----------|------|-----|---|---|-----|---|---|
| <b>X5</b> | Ind. | *E% | N | # | #%  | = | / |
|           | 10   | 100 | 1 | 1 | 100 | 0 | 0 |

|           |      |     |   |   |     |   |   |
|-----------|------|-----|---|---|-----|---|---|
| <b>V8</b> | Ind. | *E% | N | # | #%  | = | / |
|           | 8    | 50% | 2 | 1 | 50% | 0 | 0 |

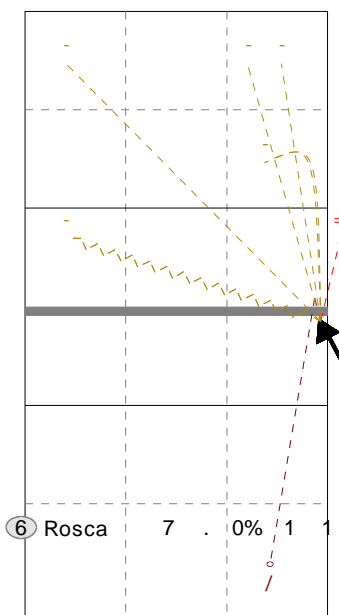

H: 71%(5) P: 14%(1) T: 14%(1)

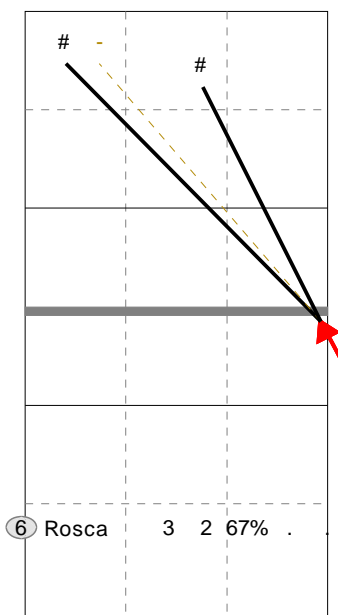

H: 100%(3) P: (0) T: (0)

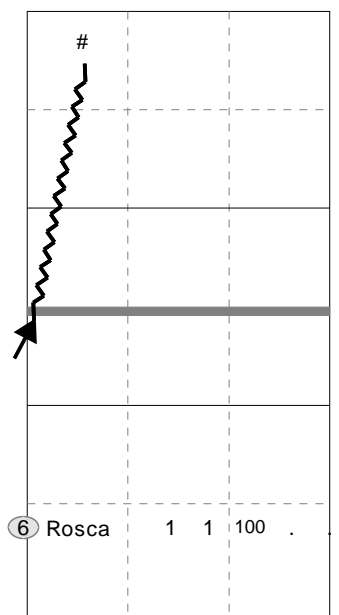

H: (0) P: 100%(1) T: (0)

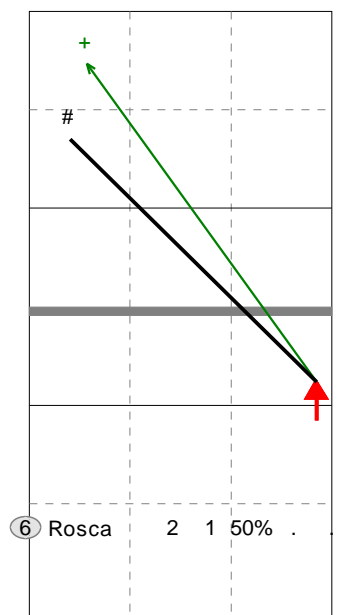

H: 100%(2) P: (0) T: (0)



Selected match: (2) BUL19, BUL19

Analysis selection

Romania | 9 Ursachi | Attack | (X2,X1,XC,X7)

| X7 | Ind. | *E% | N | # | #%  | = | / |
|----|------|-----|---|---|-----|---|---|
|    | 8    | 50% | 4 | 2 | 50% | 0 | 0 |

| X1 | Ind. | *E% | N | # | #%  | = | / |
|----|------|-----|---|---|-----|---|---|
|    | 5    | .   | 2 | 1 | 50% | 1 | 0 |

| XC | Ind. | *E% | N | # | #%  | = | / |
|----|------|-----|---|---|-----|---|---|
|    | 10   | 100 | 1 | 1 | 100 | 0 | 0 |

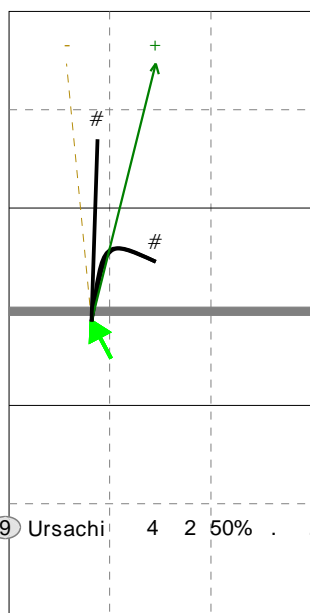

H: 75%(3) P: (0) T: 25%(1)

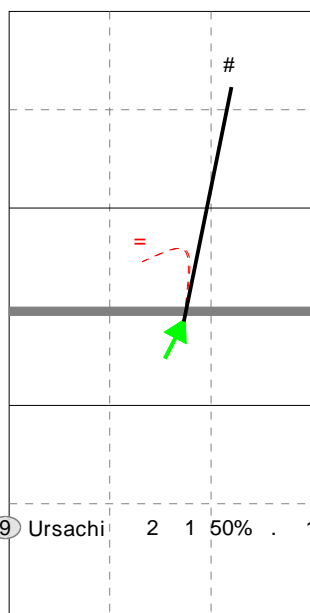

H: 50%(1) P: (0) T: 50%(1)

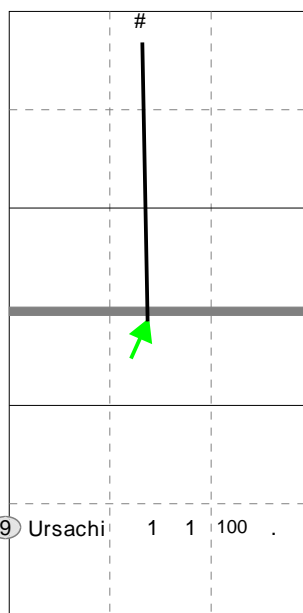

H: 100%(1) P: (0) T: (0)



Tip Soft

Selected match: (2) BUL19, BUL19

Analysis selection

Romania | 10 Teanu | Attack | (XF,X2,X1,XM,XG,XC,X7,X9,XT,X3,X4,XB,XP,XR,X5,X0,X6,X8,CB,CF,CD,C5,C0,C6,C8,V5,V0,V6,V8,VB,VP,VR)

**X6** Ind. \*E% N # #% = /  
6 12% 17 6 35% 1 3

**V6** Ind. \*E% N # #% = /  
5 -7% 15 4 27% 1 4

**V5** Ind. \*E% N # #% = /  
5 . 12 4 33% 2 2

**V8** Ind. \*E% N # #% = /  
6 11% 9 3 33% 2 0

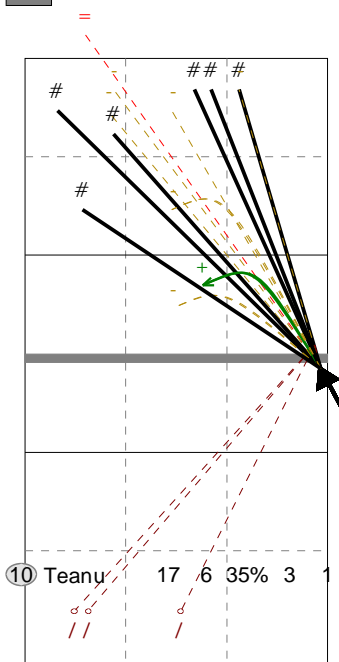

H: 82%(14) P: (0) T: 18%(3)

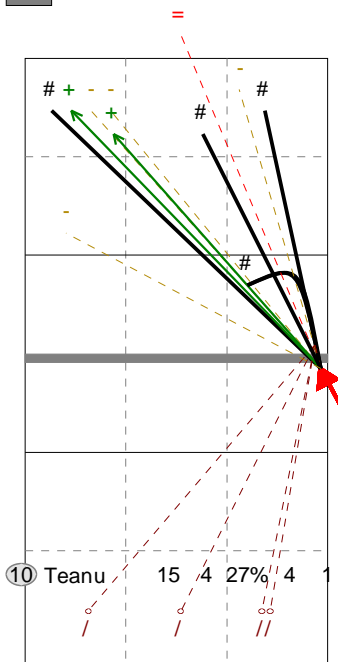

H: 87%(13) P: 7%(1) T: 7%(1)

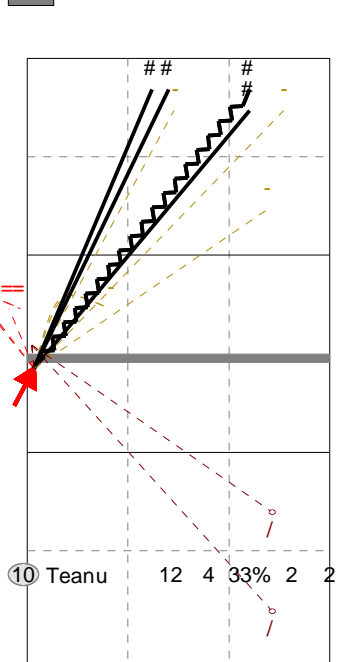

H: 67%(8) P: 17%(2) T: 17%(2)

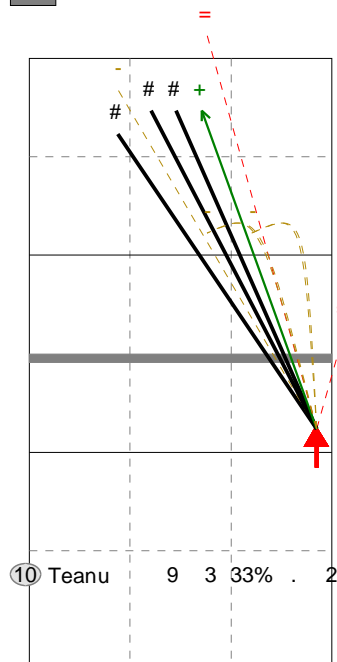

H: 78%(7) P: (0) T: 22%(2)

**X5** Ind. \*E% N # #% = /  
6 12% 8 3 38% 2 0

**X8** Ind. \*E% N # #% = /  
5 . 3 1 33% 1 0

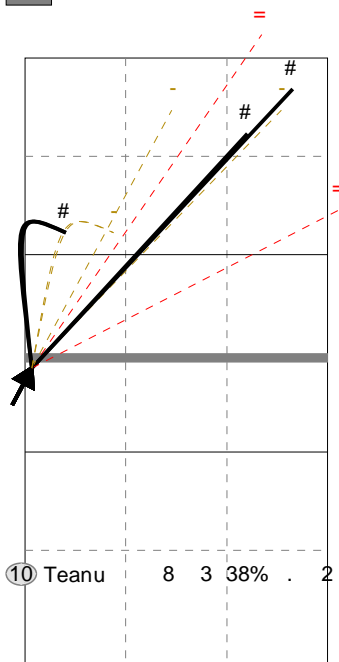

H: 75%(6) P: (0) T: 25%(2)

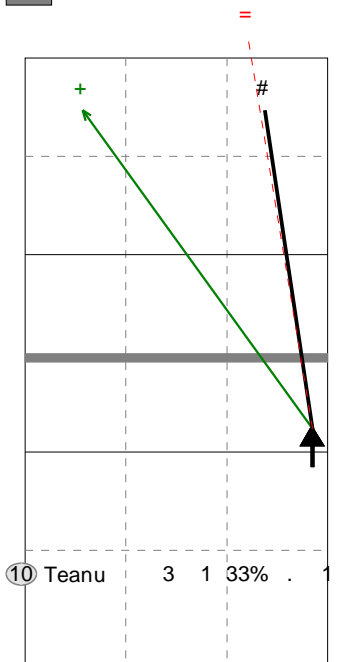

H: 100%(3) P: (0) T: (0)



Selected match: (2) BUL19, BUL19

Analysis selection

Romania | 11 Mocan | Attack

|    |      |     |   |   |     |   |   |
|----|------|-----|---|---|-----|---|---|
| PP | Ind. | *E% | N | # | #%  | = | / |
|    | 8    | 50% | 8 | 5 | 62% | 0 | 1 |

|    |      |     |   |   |    |   |   |
|----|------|-----|---|---|----|---|---|
| P2 | Ind. | *E% | N | # | #% | = | / |
|    | 5    | .   | 1 | 0 | 0% | 0 | 0 |

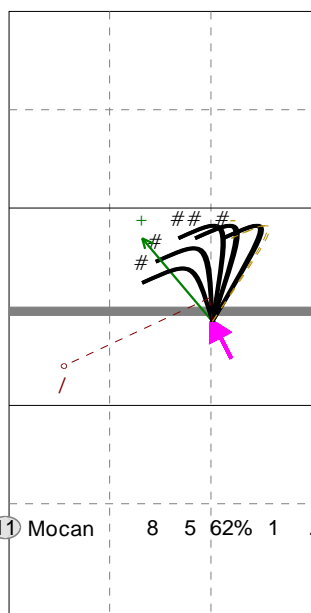

H: 25%(2) P: (0) T: 75%(6)

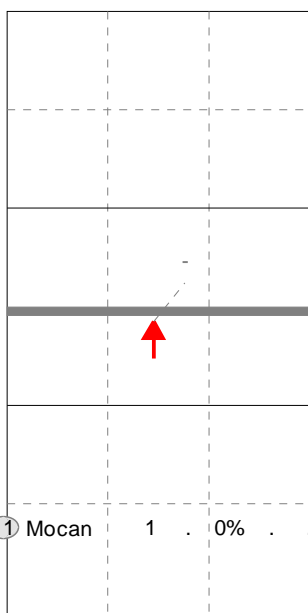

H: 100%(1) P: (0) T: (0)



Selected match: (2) BUL19, BUL19

Analysis selection

Romania | 13 Rus | Attack | (XF,X2,X1,XM,XG,XC,X7,X9,XT,X3,X4,XB,XP,XR,X5,X0,X6,X8,CB,CF,CD,C5,C0,C6,C8,V5,V0,V6,V8,VB,VP,VR)

**X5** Ind. \*E% N # #% = /  
5 -8% 13 2 15% 2 1

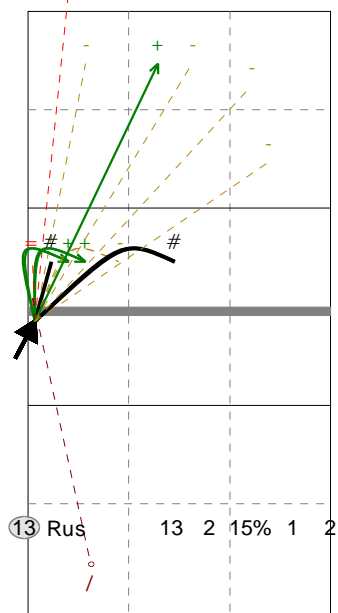

H: 69%(9) P: (0) T: 31%(4)

**V5** Ind. \*E% N # #% = /  
6 30% 10 5 50% 2 0

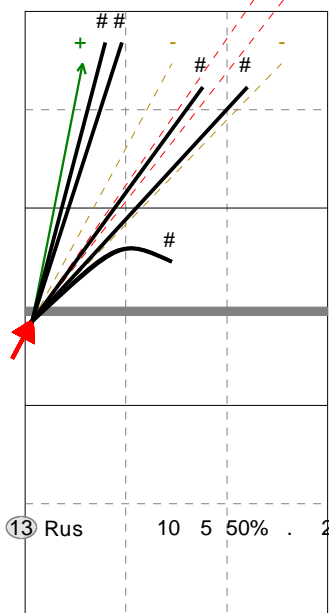

H: 90%(9) P: (0) T: 10%(1)

**X6** Ind. \*E% N # #% = /  
7 33% 3 1 33% 0 0

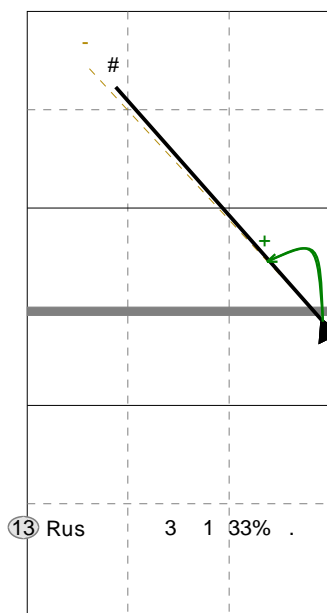

H: 67%(2) P: (0) T: 33%(1)

**XP** Ind. \*E% N # #% = /  
. -100 1 0 0% 1 0

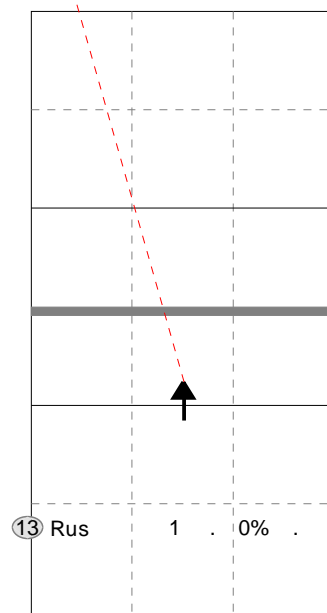

H: 100%(1) P: (0) T: (0)

**V8** Ind. \*E% N # #% = /  
5 . 1 0 0% 0 0

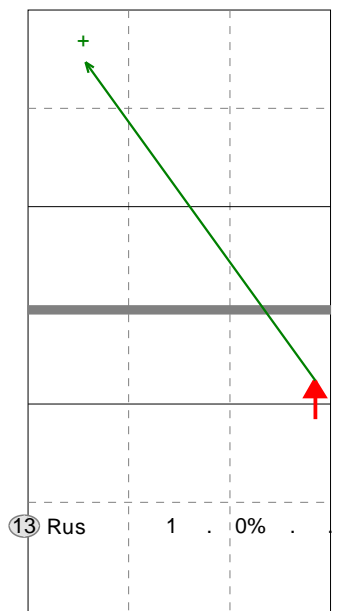

H: 100%(1) P: (0) T: (0)

**VP** Ind. \*E% N # #% = /  
5 . 1 0 0% 0 0

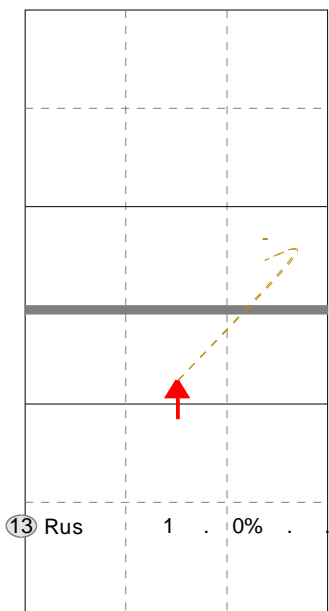

H: (0) P: (0) T: 100%(1)



Selected match: (2) BUL19, BUL19

Analysis selection

Romania | 14 Marin | Attack | (X2,X1,XC,X7)

|           |      |     |   |   |     |   |   |
|-----------|------|-----|---|---|-----|---|---|
| <b>X1</b> | Ind. | *E% | N | # | #%  | = | / |
|           | 8    | 67% | 9 | 6 | 67% | 0 | 0 |

|           |      |     |   |   |     |   |   |
|-----------|------|-----|---|---|-----|---|---|
| <b>XC</b> | Ind. | *E% | N | # | #%  | = | / |
|           | 6    | 11% | 9 | 3 | 33% | 1 | 1 |

|           |      |     |   |   |     |   |   |
|-----------|------|-----|---|---|-----|---|---|
| <b>X7</b> | Ind. | *E% | N | # | #%  | = | / |
|           | 8    | 50% | 8 | 5 | 62% | 0 | 1 |

|           |      |      |   |   |    |   |   |
|-----------|------|------|---|---|----|---|---|
| <b>X2</b> | Ind. | *E%  | N | # | #% | = | / |
|           | .    | -100 | 1 | 0 | 0% | 0 | 1 |

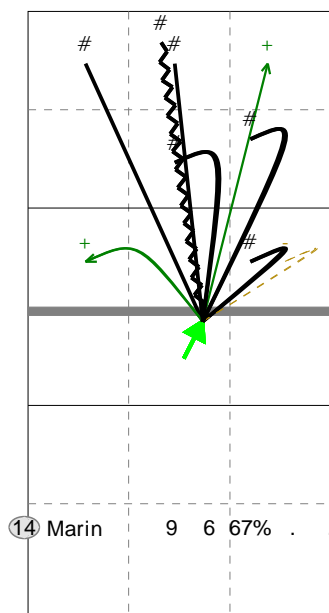

H: 33%(3) P: 11%(1) T: 56%(5)

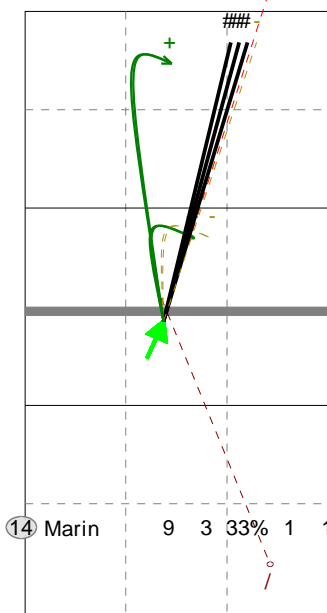

H: 67%(6) P: (0) T: 33%(3)

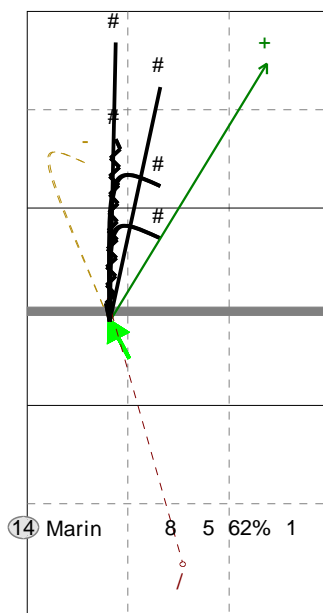

H: 50%(4) P: 12%(1) T: 38%(3)

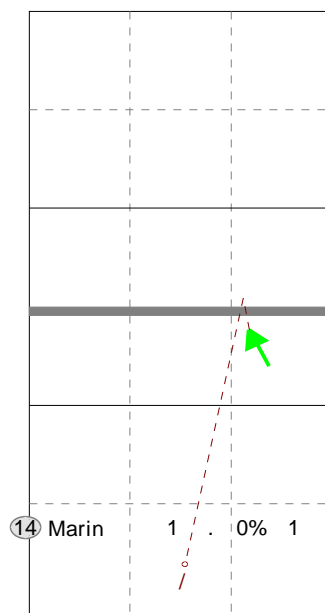

H: 100%(1) P: (0) T: (0)





Selected match: (2) BUL19, BUL19

Analysis selection

Romania | 16 Matei | Attack | (XF,X2,X1,XM,XG,XC,X7,X9,XT,X3,X4,XB,XP,XR,X5,X0,X6,X8,CB,CF,CD,C5,C0,C6,C8,V5,V0,V6,V8,VB,VP,VR)

|           |      |     |    |   |     |   |   |
|-----------|------|-----|----|---|-----|---|---|
| <b>V5</b> | Ind. | *E% | N  | # | #%  | = | / |
|           | 5    | 8%  | 13 | 3 | 23% | 2 | 0 |

|           |      |     |    |   |     |   |   |
|-----------|------|-----|----|---|-----|---|---|
| <b>X5</b> | Ind. | *E% | N  | # | #%  | = | / |
|           | 7    | 42% | 12 | 6 | 50% | 0 | 1 |

|           |      |     |   |   |    |   |   |
|-----------|------|-----|---|---|----|---|---|
| <b>VP</b> | Ind. | *E% | N | # | #% | = | / |
|           | 5    | .   | 2 | 0 | 0% | 0 | 0 |

|           |      |     |   |   |     |   |   |
|-----------|------|-----|---|---|-----|---|---|
| <b>XP</b> | Ind. | *E% | N | # | #%  | = | / |
|           | 10   | 100 | 1 | 1 | 100 | 0 | 0 |

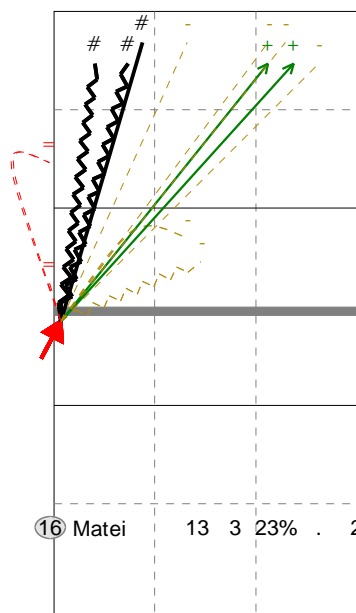

H: 62%(8) P: 23%(3) T: 15%(2)

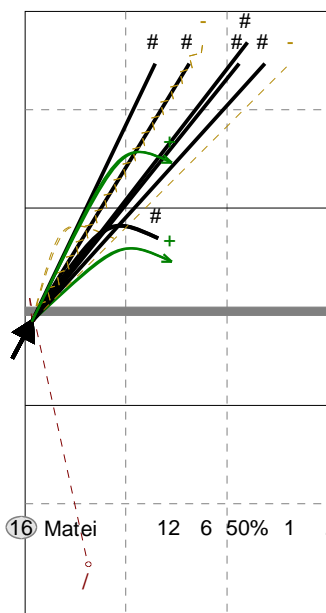

H: 58%(7) P: 8%(1) T: 33%(4)

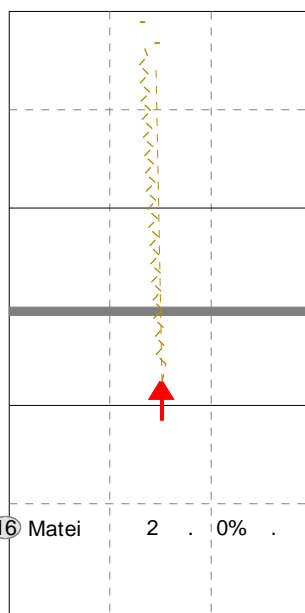

H: 50%(1) P: 50%(1) T: (0)

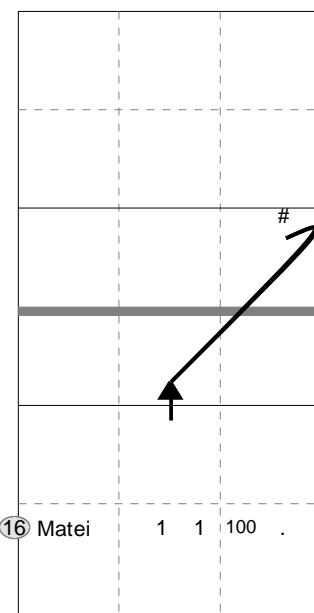

H: (0) P: (0) T: 100%(1)



Selected match: (2) BUL19, BUL19

Analysis selection

Romania | 17 Petromaneant | Attack | (XF,X2,X1,XM,XG,XC,X7,X9,XT,X3,X4,XB,XP,XR,X5,X0,X6,X8,CB,CF,CD,C5,C0,C6,C8,V5,V0,V6,V8,VB,VP,VR)

|           |      |     |   |   |     |   |   |
|-----------|------|-----|---|---|-----|---|---|
| <b>X5</b> | Ind. | *E% | N | # | #%  | = | / |
|           | 5    | .   | 5 | 1 | 20% | 0 | 1 |

|           |      |     |   |   |    |   |   |
|-----------|------|-----|---|---|----|---|---|
| <b>V5</b> | Ind. | *E% | N | # | #% | = | / |
|           | 3    | -33 | 3 | 0 | 0% | 1 | 0 |

|           |      |     |   |   |    |   |   |
|-----------|------|-----|---|---|----|---|---|
| <b>VP</b> | Ind. | *E% | N | # | #% | = | / |
|           | 5    | .   | 2 | 0 | 0% | 0 | 0 |

|           |      |     |   |   |     |   |   |
|-----------|------|-----|---|---|-----|---|---|
| <b>XP</b> | Ind. | *E% | N | # | #%  | = | / |
|           | 10   | 100 | 1 | 1 | 100 | 0 | 0 |

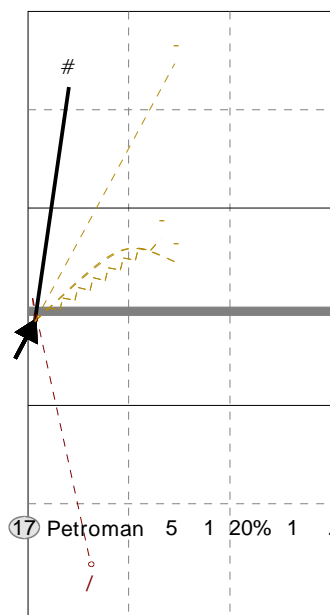

H: 60%(3) P: 20%(1) T: 20%(1)

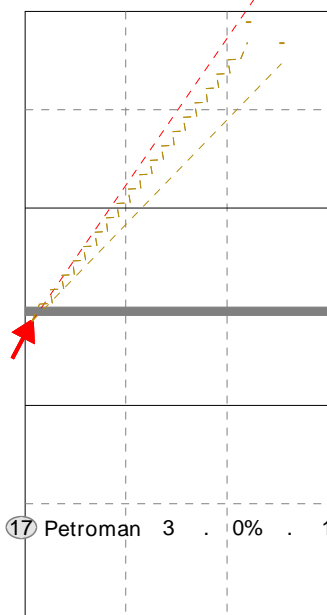

H: 67%(2) P: 33%(1) T: (0)

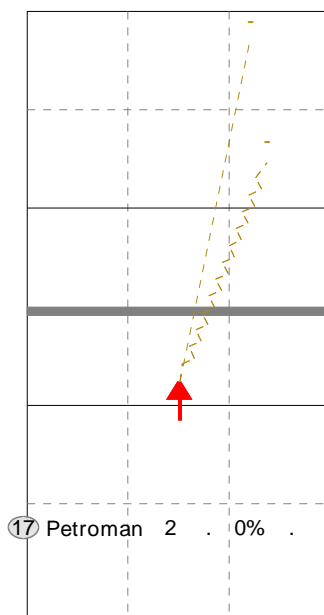

H: 50%(1) P: 50%(1) T: (0)

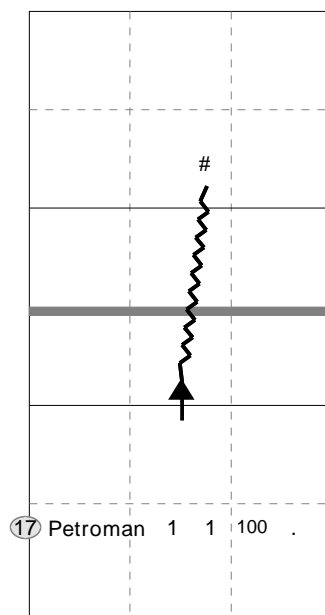

H: (0) P: 100%(1) T: (0)

